

Vision® Wired

Wired Analog Room Thermostat
24-230V

WT-A03



- ✓ 24-230V ~
- ✓ NO/NC

WATTS
CONNECT. CONTROL. CONSERVE.

- DE Analoger kabelgebundener Raumthermostat
- FR Thermostat d'ambiance analogique filaire
- EN Wired analog room thermostat
- NL Analoge bedrade kamerthermostaat
- IT Termostato ambiente cablato analogico
- ES Termostato ambiente con cable analógico
- NO Analog kablet romtermostat
- FI Analoginen langallinen huonetermostaatti
- RU Аналоговый проводной комнатный термостат
- DA Analog kablet rumtermostat
- SV Analog trådbunden rumstermostat



1 x



1 x



1 x

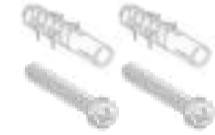

<https://www.watts.eu/en/products/eu/smart-home-and-controls/vision-wired/analog-room-thermostat-wt-a03>

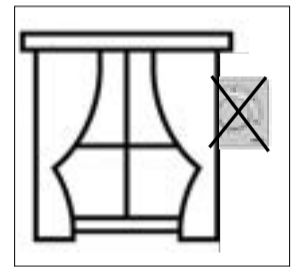
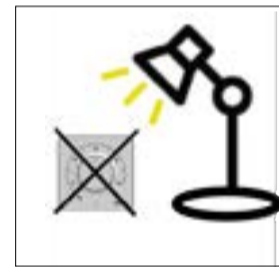
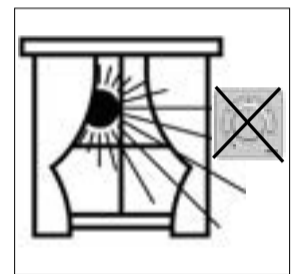
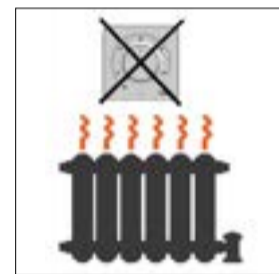
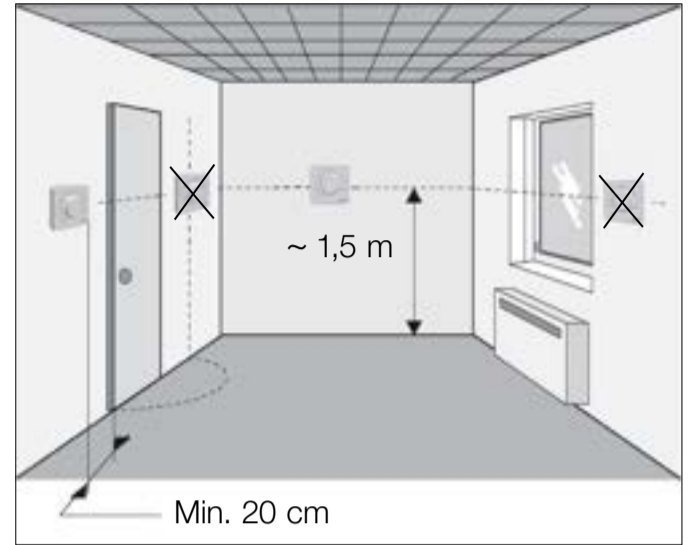

Sicherheitshinweise und Betriebsanleitungen

Dieses Produkt sollte von einem qualifizierten Fachmann gemäß allen geltenden Vorschriften und Normen installiert werden. Alle Anweisungen in dieser Installations- und Bedienungsanleitung sind bei der Arbeit mit dem Thermostat zu beachten. Ausfälle aufgrund unsachgemäßer Installation, unsachgemäßer Verwendung oder mangelhafter Wartung führen zum Erlöschen der Herstellerhaftung. Trennen Sie vor Arbeitsbeginn die Stromversorgung! Alle Installations- und Verdrahtungsarbeiten des Thermostats dürfen nur im spannungslosen Zustand durchgeführt werden. Die Thermostate sind weder spritz- noch tropfwassergeschützt. Daher müssen sie an einem trockenen Ort montiert werden.

Avertissements de sécurité et consignes d'utilisation

Ce produit doit être installé par un professionnel qualifié conformément à toutes les réglementations et normes applicables. Toutes les instructions de ce manuel d'installation et d'utilisation doivent être respectées lorsque vous travaillez avec le thermostat. Les défaillances dues à une mauvaise installation, une mauvaise utilisation ou un mauvais entretien annulent la responsabilité du fabricant. Avant de commencer le travail, débranchez l'alimentation électrique ! Tous les travaux d'installation et de câblage liés au thermostat doivent être effectués uniquement lorsqu'il est hors tension. Les thermostats ne sont ni étanches aux éclaboussures ni aux gouttes. Par conséquent, ils doivent être montés dans un endroit sec.

Safety warnings and operating instructions

This product should be installed by a qualified professional according to all applicable regulations and standard. All instructions in this Installation & Operation manual should be observed when working with the thermostat. Failures due to improper installation, improper use or poor maintenance are voiding manufacturer liability. Before starting work disconnect power supply! All installation and wiring work related to the thermostat must be carried out only when de-energized. The thermostats are neither splash- nor drip-proof. Therefore, they must be mounted at a dry place.

Veiligheidswaarschuwingen en gebruiksaanwijzingen

Dit product moet worden geïnstalleerd door een gekwalificeerde professional in overeenstemming met alle toepasselijke voorschriften en normen. Alle instructies in deze installatie- en bedieningshandleiding moeten in acht worden genomen bij het werken met de thermostaat. Storingen als gevolg van onjuiste installatie, onjuist gebruik of slecht onderhoud maken de aansprakelijkheid van de fabrikant ongeldig. Voor aanvang van de werkzaamheden de stroomtoevoer loskoppelen! Alle installatie- en bedringswerkzaamheden met betrekking tot de thermostaat mogen alleen spanningsloos worden uitgevoerd. De thermostaten zijn niet spatwater- of druppeldicht. Daarom moeten ze op een droge plaats worden gemonteerd.

Avvertenze di sicurezza e istruzioni d'uso

Questo prodotto deve essere installato da un professionista qualificato secondo tutte le normative e gli standard applicabili. Tutte le istruzioni in questo manuale di installazione e funzionamento devono essere osservate quando si lavora con il termostato. Guasti dovuti a installazione impropria, uso improprio o scarsa manutenzione annullano la responsabilità del produttore. Prima di iniziare il lavoro scollegare l'alimentazione! Tutti i lavori di installazione e cablaggio relativi al termostato devono essere eseguiti solo quando disaccoppiato. I termostati non sono né a prova di schizzi né di gocciolamento. Pertanto, devono essere montati in un luogo asciutto.

Advertencias de seguridad e instrucciones de uso

Este producto debe ser instalado por un profesional calificado de acuerdo con todas las regulaciones y estándares aplicables. Se deben observar todas las instrucciones de este manual de instalación y funcionamiento cuando se trabaja con el termostato. Las fallas debidas a una instalación incorrecta, un uso inadecuado o un mantenimiento deficiente anulan la responsabilidad del fabricante. ¡Antes de comenzar a trabajar, desconecte la fuente de alimentación! Todo el trabajo de instalación y cableado relacionado con el termostato debe realizarse solo cuando está desenergizado. Los termostatos no son a prueba de salpicaduras ni de goteo. Por lo tanto, deben montarse en un lugar seco.

Sikkerhetsadvarsler og bruksanvisning

Dette produktet skal installeres av en kvalifisert fagperson i samsvar med alle gjeldende forskrifter og standarder. Alle instruksjoner i denne installasjons- og bruksanvisningen skal følges når du arbeider med termostaten. Feil på grunn av feil installasjon, feil bruk eller dårlig vedlikehold annullerer produsentens ansvar. Koble fra strømforsyningen før du starter arbeidet! Alt installasjons- og ledningsarbeid relatert til termostaten må bare utføres når strømmen er slått av. Termostatene er verken sprut- eller dryppsikre. Derfor må de monteres på et tørt sted.

Turvavaroitukset ja toimintaohjeet

Tämän tuotteen tulee asentaa pätevä ammattilainen kaikkien sovellettavien määräysten ja standardien mukaisesti. Kaikkia tämän asennus- ja käyttöohjeen ohjeita on noudatettava työskennellessä termostaatin kanssa. Väärästä asennuksesta, väärästä käytöstä tai huollosta johtuvat viat mitätöivät valmistajan vastuun. Irtota virtalähde ennen työn aloittamista! Kaikki termostaattiin liittyvät asennus- ja johdotustyöt on suoritettava vain virran ollessa kytkettyä. Termostaattit eivät ole roiske- tai tippumiskestäviä. Siksi ne on asennettava kuivaan paikkaan.

Меры предосторожности и указания по эксплуатации

Этот продукт должен быть установлен квалифицированным специалистом в соответствии со всеми применимыми правилами и стандартами. При работе с термостатом необходимо соблюдать все инструкции данного руководства по установке и эксплуатации. Сбои из-за неправильной установки, неправильного использования или плохого обслуживания аннулируют ответственность производителя. Перед началом работы отключите электропитание! Все монтажные и электромонтажные работы, связанные с термостатом, должны выполняться только в обесточенном состоянии. Термостаты не защищены от брызг и капель. Поэтому монтировать их нужно в сухом месте.

Sikkerhedsadvarsler og driftvejledning

Dette produkt skal installeres af en kvalificeret professionel i henhold til alle gældende regler og standarder. Alle instruktioner i denne installations- og betjeningsvejledning skal overholdes, når du arbejder med termostaten. Fejl på grund af ukorrekt installation, forkert brug eller dårlig vedligeholdelse annullerer producentens ansvar. Afbryd strømforsyningen inden arbejdet påbegyndes! Alt installations- og ledningsarbejde i forbindelse med termostaten må kun udføres, når den er spændingsfri. Termostaterne er hverken stænk- eller drypsikre. Derfor skal de monteres på et tørt sted.

Säkerhets- och driftsanvisningar

Denna produkt bör installeras av en kvalificerad professionell i enlighet med alla tillämpliga regler och standarder. Alla instruktioner i denna installations- och bruksanvisning bör följas när du arbetar med termostaten. Fel på grund av felaktig installation, felaktig användning eller dåligt underhåll upphäver tillverkarens ansvar. Koppla bort strömförsörjningen innan arbetet påbörjas! Allt installations- och ledningsarbete relaterat till termostaten får endast utföras när den är spänningsatt. Termostaterna är varken stänk- eller droppsäkra. Därför måste de monteras på en torr plats.

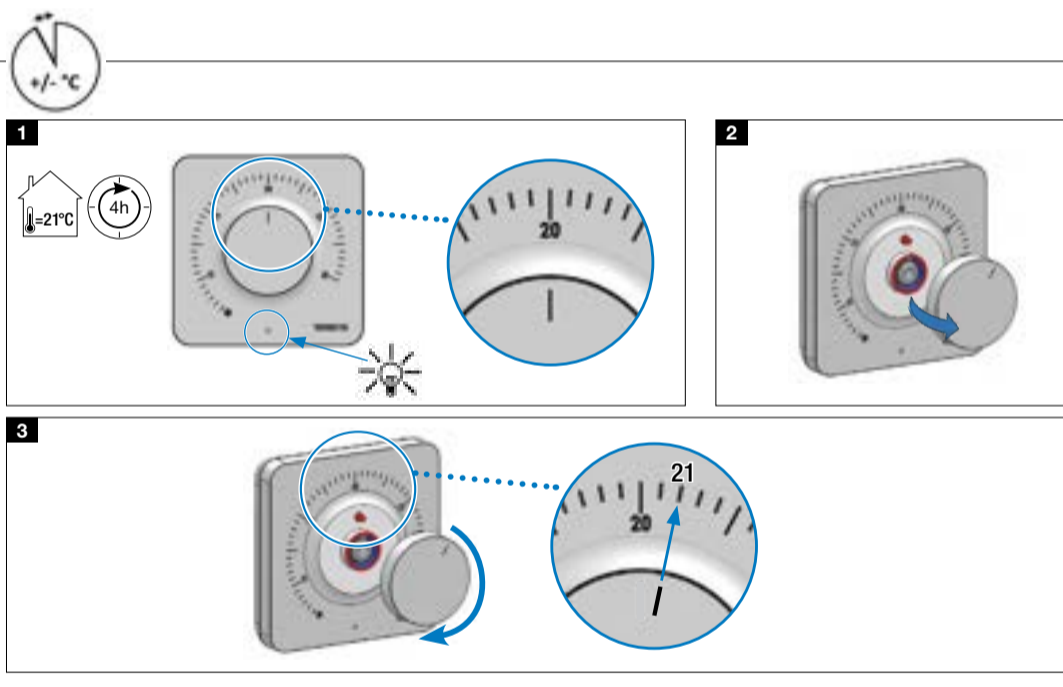
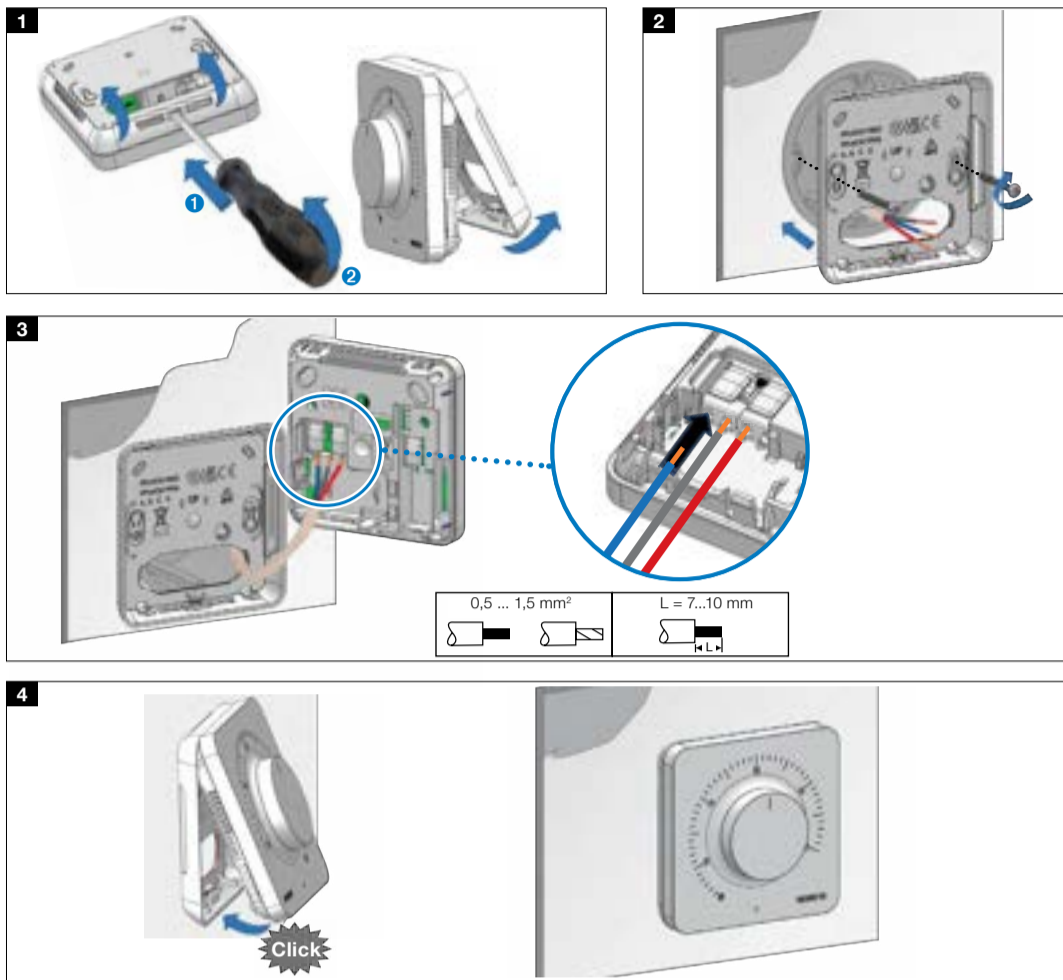

Environmental:	
Operating temperature	0°C to +40°C (32°F to +104°C),
Shipping and storage temperature	-10°C to +50°C (14°F to +122°C)
Electrical protection	
Security isolation	IP30
ErP Class	Class II
Energy efficiency gain	Level I
Temperature precision	1%
Temperature precision	
Setting temperature range Comfort	0.1°C
Antifreeze	+7°C to +30°C (0.5°C step)
	+7°C
Regulation type	Hysteresis ± 0.6°C
Power supply	From 24V to 240VAC 50Hz
Power output	Live Triac, NO or NC
	24VAC: Max. 5 electrothermal actuators (1,6W / actuator)
	230VAC: Max. 8 electrothermal actuators (1,8W / actuator)
	Peak of current : 4A max
Internal temperature sensor	NTC 10kΩ at +25°C

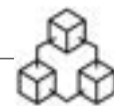
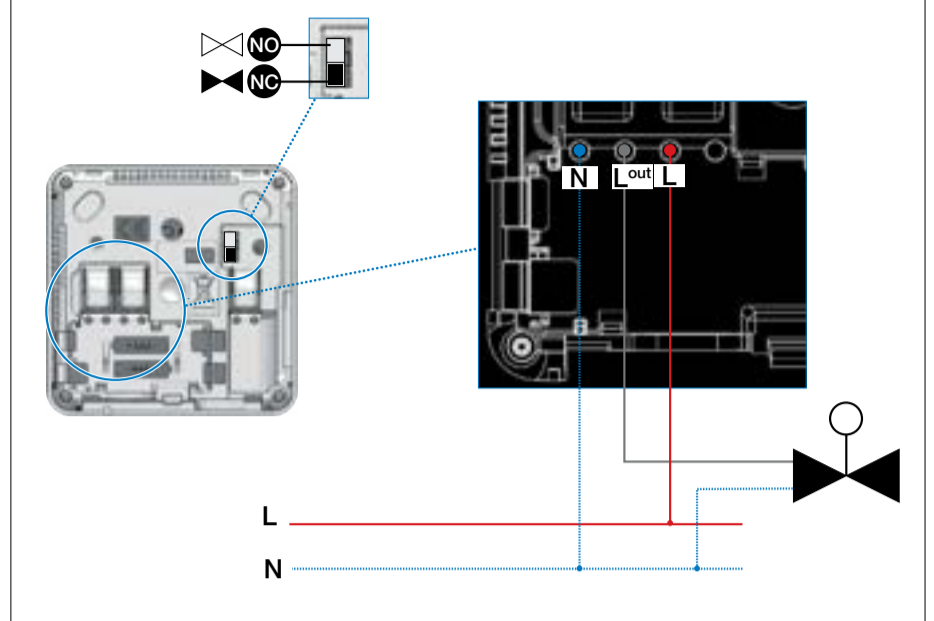

Vision® Wired

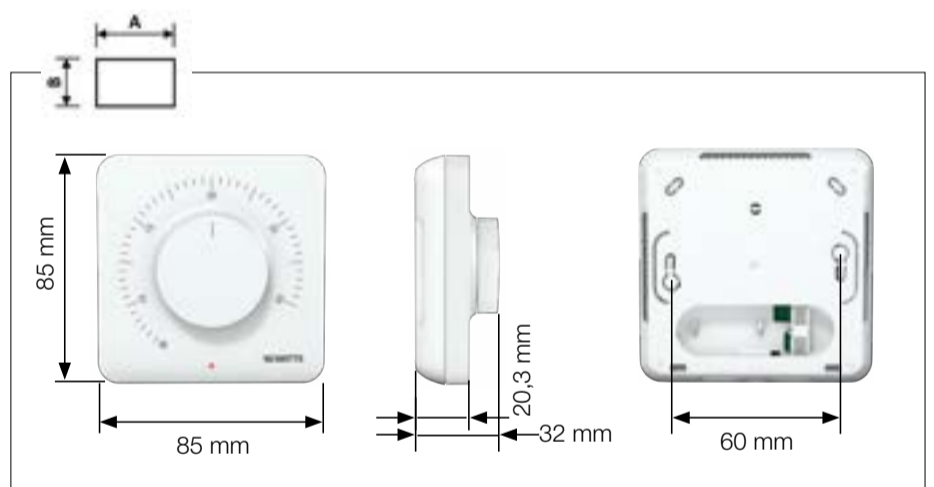
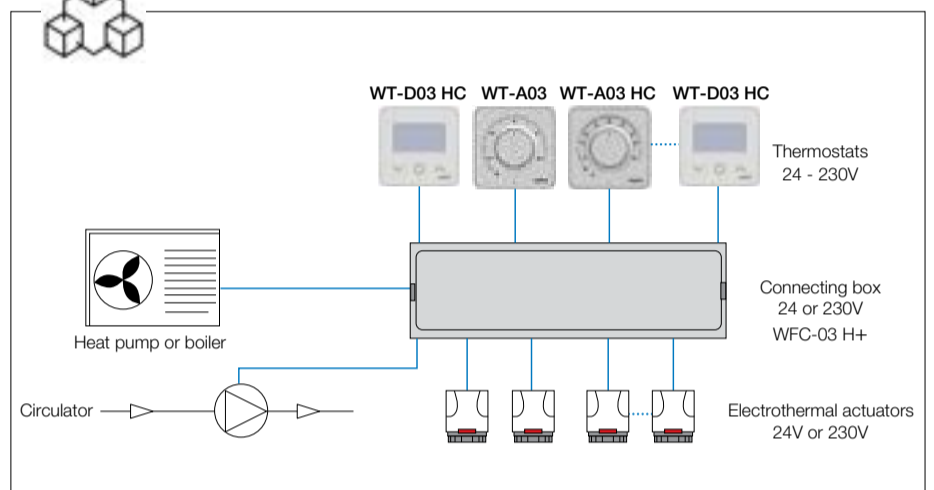

The descriptions and photographs contained in this document are supplied by way of example and illustration only. Watts Industries reserves the right to carry out any technical and design improvements to its products without prior notice. Watts hereby objects to any term, different from or additional to Watts terms, contained in any buyer communication in any form, unless agreed to in a writing signed by an officer of Watts.

2012/19/EU: Products marked with this symbol cannot be disposed of as unsorted municipal waste in the European Union. For proper recycling, return this product to your local supplier upon the purchase of equivalent new equipment, or dispose of it at designated collection points. For more information see: www.recyclethis.info



Vision® Wired
watts.eu